

JENSEN®

How to Enjoy Your XCH 6RF 6-Disc Compact Disc Changer

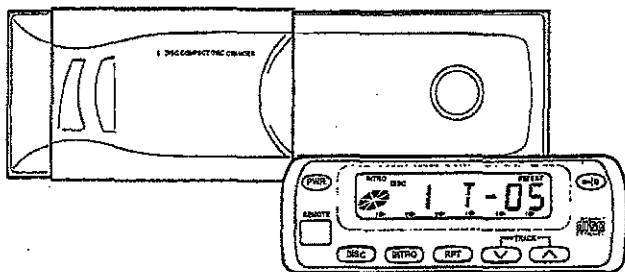

Welcome!

What you're holding in your hands is no ordinary owner's manual. We've tried to make the instructions in this owner's manual clear and easy to follow. If you take a few minutes to look through it, you'll learn how to use all of the features on your new Jensen CD changer for maximum enjoyment.

For your Jensen CD changer to work right, it must be installed correctly. The enclosed installation manual will show you how to install your new CD changer like a pro. It's a good idea to read all of these instructions before you begin the installation. Most installations are straightforward and can be handled by a do-it-yourselfer with the right tools, patience, and the ability to follow instructions. But, do-it-yourself installation isn't for everyone. If you still don't feel confident after reading this book, consider turning the installation job over to someone better suited to it.

Warranty Service

If your Jensen CD changer should ever require service, you will need to have the original dated receipt. If you ever need to return the unit for any reason, always include the receipt with the product.



Technical Assistance

For technical assistance with the operation of the XCH 6RF, call 1-800-323-0221.

Operation

XCH 6RF Features

Playing Compact Discs	2
Controls	2
Power/Start Playing	2
Play/Pause CD	3
Select Disc	3
Skip Tracks	3
Repeat the Same Track	3
Intro: Preview All Tracks	3
Program CD Playback	4
Reset	4
Loading the CD Changer	5
Insert compact discs in the magazine	5
Remove compact discs from the magazine	5
Load the magazine into the CD changer	5
Troubleshooting	6
Specifications and Warranty	7

Playing Compact Discs

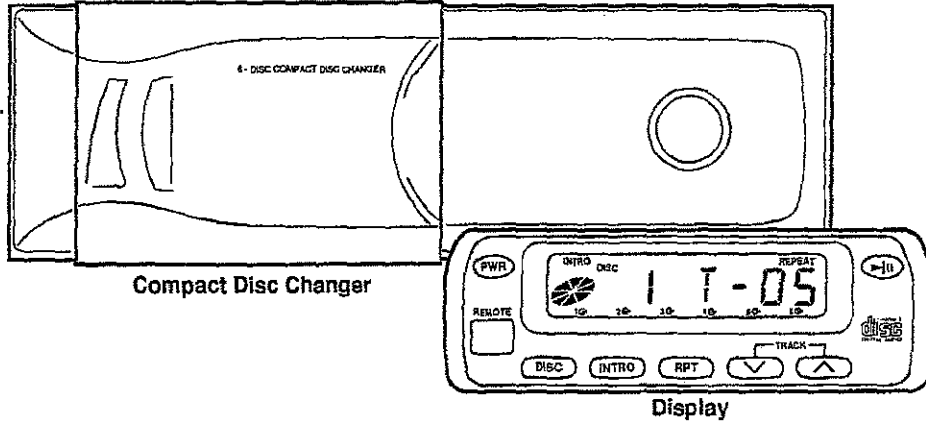

Compact Disc Changer

Display

Controls

Control the CD changer with the display.

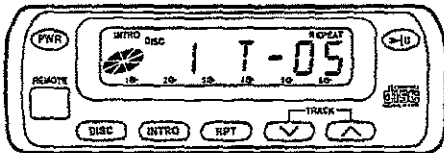

Power/Start Playing

1. Turn on the radio and tune to FM station selected on the modulator (88.7 or 89.1 FM). Leave in stereo operation.



2. Press **PWR** button once to turn the XCH 6RF on. CD will begin to play. Press again to turn it off.

Play/Pause CD

1. Press **Play/Pause** (▶||) while CD changer is playing to pause CD play.



2. Press again to continue disc play.

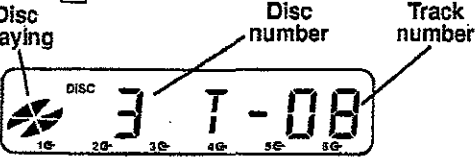

The compact disc changer plays all songs on a disc, then advances to the next disc in order (1-2-3-4-5-6).

Skip Tracks

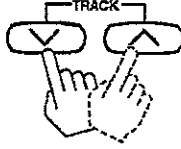

Press **TRACK** (▼ or ▲) button to go to another track on the current disc.

Repeat the Same Track



Press **RPT** to continuously repeat the same track.

Press again to stop repeat.



Intro: Preview all Tracks



Press **INTRO** to play the first ten seconds of each track on all discs in the magazine. Press again to stop "INTRO" and listen to track.



Select Disc

The magazine holds up to 6 compact discs, numbered 1 to 6 (starting at the bottom).



Press **DISC** to select the next disc in order.

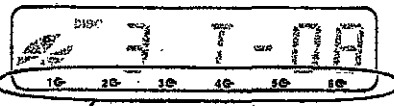

The display indicates which discs are loaded in the magazine.

The compact disc changer begins playing the first track on the next disk.

If you press **DISC** while a disc is playing, the current disc stops immediately and the next disc plays.

Reset

Press **RESET** only when one of these conditions occur:

- The compact disc changer is first installed
- There is an error in operation (E01, E02, E03 or E06 may appear on the display).
- Vehicle power is interrupted (as when replacing the battery).

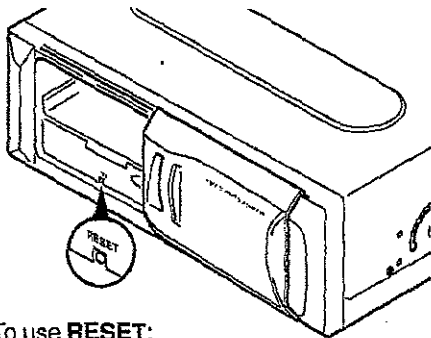

To use **RESET**:

1. Open the compact disc changer door, then use a pencil tip (or other non-metallic object) to press the **RESET** button. The compact disc changer ejects the magazine. Any disc being played is not returned to the magazine.
2. Remove all compact discs from the magazine.
3. Reinstall the empty magazine. The compact disc changer returns the compact disc to the magazine and ejects the magazine again.
4. Press **RESET** again.

Loading the CD Changer

Insert Compact Discs in the Magazine

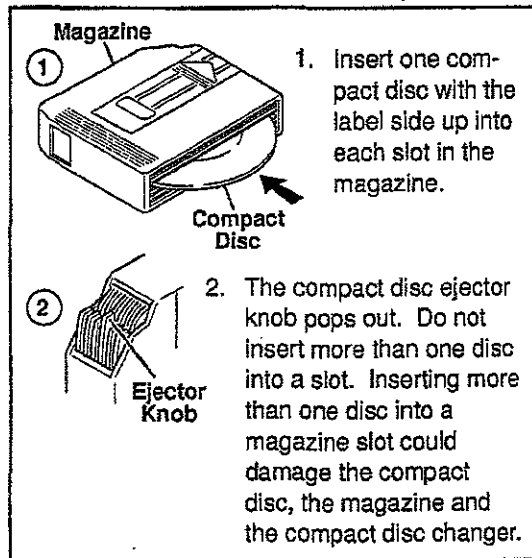

Remove Compact Discs from the Magazine

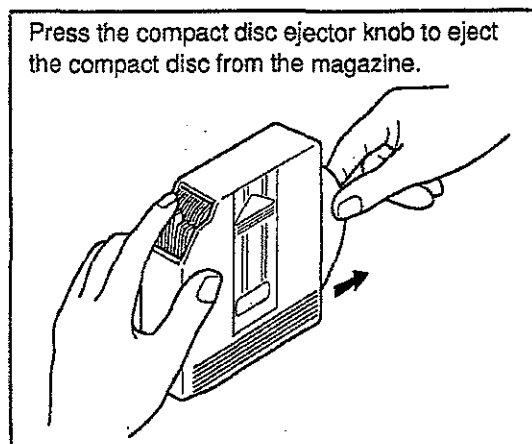

Load the Magazine into the CD Changer

Slide compact disc changer door to the right. Insert magazine. Close door. You will hear the XCH 6RF check how many discs are in the magazine.

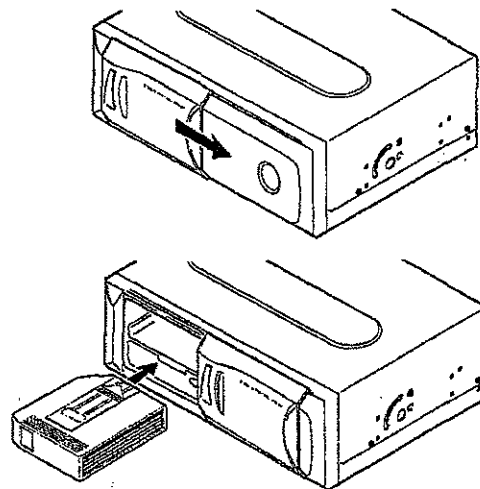

To remove the magazine, open the door and press the eject button ▲.

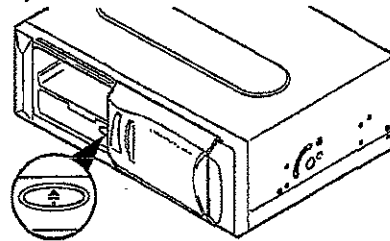

Note: Always keep the compact disc changer door closed during operation.

Troubleshooting

Problem	Cause	Correction
CD changer does not operate	Fuse blown	Locate and replace fuse
	Bad ground to CD changer	Locate and repair ground
	CD changer overheated	Allow air to circulate around changer
	Magazine not installed/no discs in magazine/discs installed incorrectly	Install discs and magazine
Disc is playing but there is no sound	Poor connections to FM modulator	Correct connections at modulator, CD changer and receiver
	Bad ground on FM modulator	Locate and repair ground connection
	Fuse blown	Locate and replace fuse
	Receiver not tuned to correct station (88.7 or 89.1 FM)	Tune receiver
	Condensation (moisture) on CD changer laser optics (occurs in humid, rainy conditions or after turning on the heater)	Remove magazine, leave CD changer door open and wait approximately one hour
Music "skips" excessively when going over bumps	Shipping screws not removed	Remove shipping screws
	Vertical/horizontal position not selected correctly	Select position
	Unit installed at an angle more than 15 degrees from vertical or horizontal	Reinstall properly
"E01", "E02", "E03" or "E06" appears on display	Disc loading or eject malfunction	Press "RESET" button Insert a disc and try again
"E08" appears on display	Disc dirty	Clean the disc
	Disc inserted incorrectly	Insert the disc correctly
Can't find problem		Contact Jensen Technical Assistance (1-800-323-0221)

Specifications

Frequency response (+/- 2dB)	20 Hz - 20 kHz
Signal/noise ratio	≥90 dB at 1kHz
Stereo separation @ 1 kHz	≥70 dB
Total harmonic distortion @ 1 kHz	≤0.1%

General

Power supply	10-16 VDC, negative ground
Dimensions	11.4" X 3.5" X 7.7" (284mm X 74mm X 186.5mm)
Weight	5.5 lbs. (2.5 kg)
FM modulator frequency	88.7 MHz/89.1 MHz

Specifications subject to change without notice.

Limited One Year Warranty-USA and Canada

Length of Warranty. This warranty from Recoton Mobile Electronics shall be in effect for a period of one year from the date of the first consumer purchase.

Persons Protected. This warranty will be enforceable by the original owner and any subsequent owners during the warranty period so long as proof of date of purchase from an authorized Jensen dealer is presented whenever warranty service is required.

What is Covered. Except as otherwise specified below, this warranty covers all defects in material and workmanship in this product. The following are not covered: damage resulting from accident, misuse, abuse, neglect, product modification, improper installation, incorrect line voltage, unauthorized repair or failure to follow instructions supplied with the product; damage occurring during shipment (claims must be presented to the carrier); elimination of car static or other electrical interferences; any product purchased outside USA or Canada, or on which the serial number has been defaced, modified or removed.

How You Can Get Service.

U.S. Purchasers. Please telephone Jensen at 1-800-323-4815. We will either inform you of the name and address of an authorized Jensen repair station which will service the product or will advise you to send the product to a factory service center.

Canadian Purchasers. The product should be returned to the Jensen dealer from whom it was purchased and such dealer either will service or arrange for service of the product.

If shipment of the product is required, it should be packed securely. The original dated bill of sale must always be included with the product as proof of warranty coverage.

What We Will Pay For. We will pay for all labor and material expenses required to repair the product, but you must pay any labor costs for the removal and/or installation of the product. If the product is shipped for warranty service, you must prepay the initial shipping charges, but Jensen will pay the return shipping charges if the product is returned to an address inside the USA or Canada.

Limitation of Implied or Statutory Warranties and Conditions. All implied or statutory warranties and conditions, including warranties or conditions of merchantability, fitness for particular purposes and non-infringement, are limited in duration to the length of this warranty.

Exclusion of Certain Damages. Jensen's liability is limited to the repair or replacement, at our option, of any defective product and shall not include incidental or consequential economic damages of any kind.

Some states and/or provinces do not allow limitations on how long an implied warranty lasts and/or do not allow the exclusion or limitation of incidental or consequential damages, so the above limitations and exclusions may not apply to you.

This warranty gives you specific legal rights, and you may also have other rights which vary from state to state and province to province.

JENSEN

Recoton Mobile Electronics
A Division of Recoton Audio Corporation
A RECOTON® COMPANY
1090 Emma Oaks Trail
Lake Mary, Florida 32746

©2002 Recoton Audio Corporation